



HYDRAULIC MEGASTORE
Serving the Hydraulics Industry Worldwide

Thread ID Document





HYDRAULIC MEGASTORE

Serving the Hydraulics Industry Worldwide

TAPERED THREADS

(Page 2-6)

- 2– BSPT
- 3– NPT
- 4– Grease Line
- 5– JIS Taper
- 6– Metric Taper

METAL SEALS

(Page 7-18)

- 7– BSPP
- 8– NPSM
- 9– JIC
- 10– JIS BSP
- 11– JIS METRIC
- 12– DKM
- 13– DKL
- 14– DKS
- 15– SAE (45° Flare)
- 16– SAE Inverted flare
- 17– Test Point (threaded)
- 18– Test Point (quick release)

SOFT SEALS

(19-33)

- 19– BSPP
- 20– DKOL
- 21– DKOS
- 22– ORFS
- 23– STAPLELOK
- 24– CROCBITE
- 25– RKV
- 26– SAE PILOT (male swivel)
- 27– SAE PILOT (female)
- 28– SAE FLANGE CODE 61
- 29– SAE FLANGE CODE 62
- 30– SAE FLANGE CODE 62C
- 31– UNO
- 32– ISO 6149
- 33– PRESSURE WASHER

BSPT

TAPERED THREADS

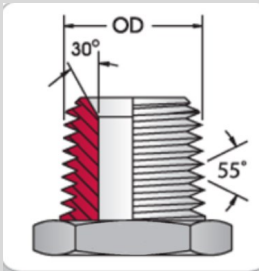

QUICK ID

Sealing Method:

Tapered thread or
30° cone seat

Thread Form:

55°

Thread Standard:

Whitworth thread

ISO 7-1:1994 BS21 AS17722-1

T200	T400	T700	T900	6900N	1100	800	3300	600
✓	✓	✓	✓	✓	✓	✓	✓	✓

BSP—BRITISH STANDARD PIPE

BSPT—BRITISH STANDARD PIPE TAPER

Measure the BSPT male thread OD and female thread ID at the first full thread near the end of the fitting. BSPT male and BSPP male with conical 30° seat (60° included angle) seal against a matching conical seat. Use of thread sealant is recommended.

BSPT THREAD SIZE & PTICH		DASH SIZE	BSPT MALE THREAD OD		BSPT FEMALE THREAD ID	
INCH	TPI		mm	INCH	mm	INCH
1/8	28	-02	9.5	0.37	8.4	0.33
1/4	19	-04	12.8	0.50	11.2	0.44
3/8	19	-06	16.3	0.64	14.7	0.59
1/2	14	-08	20.4	0.80	18.3	0.73
5/8	14	-10	22.5	0.89	20.6	0.81
3/4	14	-12	25.9	1.02	23.9	0.94
1	11	-16	32.6	1.28	29.7	1.17
1-1/4	11	-20	41.1	1.62	38.6	1.52
1-1/2	11	-24	47.0	1.85	44.5	1.75
2	11	-32	58.6	2.31	56.4	2.22
2-1/2	11	-40	74.1	2.92	71.9	2.83
3	11	-48	86.6	3.41	84.6	3.33

NPT

TAPERED THREADS

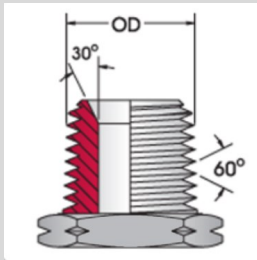

QUICK ID

Sealing Method:

Tapered thread or
30° cone seat

Thread Form:

60°

Thread Standard:

NPTF

SAE J476

ANSI

B1.20.3

T200
✓

T400
✓

T700
✓

T900
✓

6900N
✓

1100
✓

800
✓

3300
✓

600
✓

NPT— NATIONAL PIPE TAPER

BSPT—NATIONAL PIPE TAPER FUEL

National pipe threads are similar in function to BSP threads but are not generally interchangeable. NPTF threads (also known as Dryseal) are an improvement to NPT. Controlled truncation of threads means that the metal-to-metal seal is at the root and crest of the threads in addition to the flanks of the threads.

Use of thread sealant is recommended

NPT THREAD SIZE & PTICH		DASH SIZE	NPT MALE THREAD OD		NPT FEMALE THREAD ID	
INCH	TPI		mm	INCH	mm	INCH
1/8	27	-02	9.9	0.39	8.4	0.33
1/4	18	-04	13.2	0.52	11.2	0.44
3/8	18	-06	16.6	0.65	14.7	0.58
1/2	14	-08	20.6	0.81	17.8	0.7
3/4	14	-12	26	1.02	23.4	0.92
1	11.1/2	-16	32.5	1.28	29.5	1.16
1-1/4	11.1/2	-20	41.2	1.62	38.1	1.5
1.1/2	11.1/2	-24	47.3	1.86	43.9	1.73
2	11.1/2	-32	59.3	2.33	56.4	2.22
2-1/2	8	-40	71.5	2.82	69.1	2.72
3	8	-48	87.3	3.44	84.8	3.34

GREASE LINE (UNS)

TAPERED THREADS

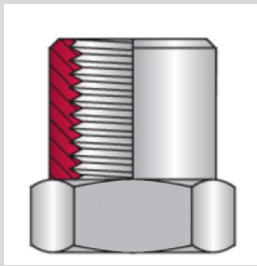

QUICK ID

Sealing Method:

Tapered thread

Thread Form:

60°

Thread Standard:

UNS

SAE J476

ANSI

B1.20.3

T200

T400

T700

T900

6900N

1100

800

3300

600



UNS UNIFIED NATIONAL—SPECIAL

1/2" UNS is commonly used in lubrication systems.

The thread size, in this case 1/2" is an actual diameter. It is not a nominal size as used in pipe threads.

UNS THREAD SIZE & PITCH		DASH SIZE	UNS FEMALE THREAD ID	
INCH	TPI		mm	INCH
1/2	27	-08	11.5	0.45

JIS TAPER

TAPERED THREADS

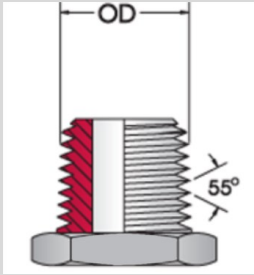

QUICK ID

Sealing Method:
Thread Form:
Thread Standard:
JIS B0203

Tapered thread
55°
Whitworth BSPT

T200	T400	T700	T900	6900N	1100	800	3300	600
✓	✓	✓	✓	✓	✓	✓	✓	✓

JIS JAPANESE INDUSTRIAL STANDARD

The Japanese tapered pipe thread connector is identical to and interchangeable with the BSPT connection. The Japanese male thread does not have a 30° cone seat and therefore it will not mate with the BSPP female swivel connector with a conical seat.

JIS THREAD SIZE & PTICH		DASH SIZE	JIS/BSPT MALE THREAD OD		JIS/BSPT FEMALE THREAD ID	
INCH	TPI		mm	INCH	mm	INCH
1/8	28	-02	9.5	0.37	8.4	0.33
1/4	19	-04	12.8	0.5	11.2	0.44
3/8	19	-06	16.3	0.64	14.7	0.59
1/2	14	-08	20.4	0.8	18.3	0.72
5/8	14	-10	22.5	0.89	20.6	0.81
3/4	14	-12	25.9	1.02	23.9	0.94
1	11	-16	32.6	1.28	29.7	1.17
1-1/4	11	-20	41.1	1.62	38.6	1.52
1-1/2	11	-24	47	1.85	44.5	1.75
2	11	-32	58.6	2.31	56.4	2.22
2-1/2	11	-40	74.1	2.92	71.9	2.83
3	11	-48	86.6	3.41	84.6	3.33

METRIC TAPER

TAPERED THREADS

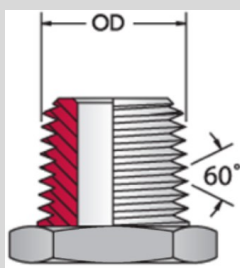

QUICK ID

Sealing Method:
 Thread Form:
 Thread Standard:
 Standard no longer used for new equipment

Tapered thread
 60°
 Metric

T200 T400 T700 T900 6900N 1100 800 3300 600

METRIC TAPER

Metric taper threads are not in common use today. The preferred alternative threads include Metric Parallel, DKL and DKS.

When a tapered thread is nominated in Europe, the term “keg” is used as a suffix. This is derived from the German word “Kegelig” meaning ‘taper’.

METRIC THREAD SIZE & PTICH		DASH SIZE	METRIC MALE THREAD ID		METRIC FEMALE THREAD OD	
SIZE	PITCH		mm	INCH	mm	INCH
M8	1.0	-08	7.9	0.31	6.9	0.27
M10	1.0	-10	9.5	0.38	8.5	0.33
M12	1.0	-12	11.1	0.44	9.9	0.39
M14	1.0	-14	12.7	0.50	11.4	0.45
M16	1.5	-16	14.3	0.56	13.0	0.51
M18	1.5	-18	19.1	0.75	17.5	0.69
M20	1.5	-20	22.2	0.88	20.3	0.80
M22	1.5	-22	27.0	1.06	24.9	0.98

BSPP

METAL SEAL

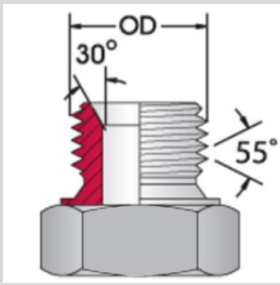

QUICK ID

Sealing Method: 30° cone seat
 Thread Form: 55°
 Thread Standard: Whitworth
 ISO 228-1 BS 2779 AS1722-2

T200 ✓ T400 ✓ T700 ✓ T900 ✓ 6900N 1100 800 ✓ 3300 ✓ 600

BSPP BRITISH STANDARD PIPE PARALLEL

BSPP threads are used on both general adaptors and on port adaptors. A soft seal is not required for general use as the connector will seal on the machined seat.

BSPP THREAD SIZE & PTICH		DASH SIZE	BSPP MALE THREAD OD		BSPP FEMALE THREAD ID	
INCH	TPI		mm	INCH	mm	INCH
1/8	28	-02	9.6	0.38	8.6	0.34
1/4	19	-04	13.0	0.51	11.9	0.47
3/8	19	-06	16.5	0.65	15.2	0.60
1/2	14	-08	20.8	0.82	19.1	0.75
5/8	14	-10	22.8	0.90	20.8	0.82
3/4	14	-12	26.3	1.04	24.6	0.97
1	11	-16	33.1	1.3	30.7	1.21
1-1/4	11	-20	41.8	1.64	39.4	1.55
1-1/2	11	-24	47.7	1.88	45.5	1.79
2	11	-32	59.5	2.34	57.4	2.6
2-1/2	11	-40	75.1	2.95	72.6	2.86
3	11	-48	87.9	3.46	85.4	3.36

NPSM

METAL SEAL

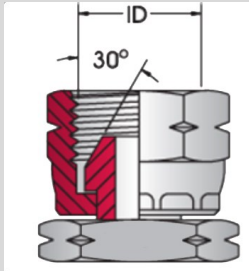

QUICK ID

Sealing Method: 30° cone seat
 Thread Form: 60°
 Thread Standard: NPSM
 SAE J476 ANSI B1.20.1-1983

T200 T400 T700 T900 6900N 1100 800 3300 600
 ✓ ✓ ✓ ✓

NPSM NATIONAL PIPE STRAIGHT MECHANICAL

NPSM is a companion thread to NPT. It is a female swivel connection with a aparallel thread to allow the male NPT to fully engage with the 30° sealing face.

NPSM THREAD SIZE & PTICH		DASH SIZE	NPSM FEMALE THREAD ID		
INCH	TPI		mm	INCH	
1/8	27	-02	8.6	0.34	
1/4	18	-04	11.9	0.47	
3/8	18	-06	15	0.59	
1/2	14	-08	19.1	0.75	
3/4	14	-12	24.6	0.97	
1	11.1/2	-16	30.5	1.20	
1-1/4	11.1/2	-20	39.4	1.55	
1-1/2	11.1/2	-24	45.5	1.79	
2	11.1/2	-32	57.4	2.26	
2-1/2	8	-40	68.8	2.71	
3	8	-48	84.6	3.33	

JIC (37° FLARE)

METAL SEAL

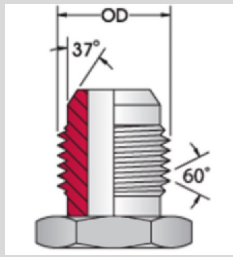

QUICK ID

Sealing Method:
Thread Form:
Thread Standard:
ISO 8434-2 SAE J516

37° cone seat
60°
UNF or UNC

T200	T400	T700	T900	6900N	1100	800	3300	600
✓	✓	✓	✓	✓	✓	✓	✓	✓

JIC JOINT INDUSTRIES COUNCIL

JIC is a very popular connector form which has developed for use with inch sized hydraulic tube. JIC always seals on the 37° cone seat located on the front face of the male.

JIC THREAD SIZE & PTICH		DASH SIZE	JIC MALE THREAD OD		JIC FEMALE THREAD ID		TUBE SIZE
INCH	TPI		mm	INCH	mm	INCH	INCH
5/16	24 UNF	-05	7.9	0.31	6.9	0.27	1/8
3/8	24 UNF	-06	9.5	0.38	8.5	0.33	3/16
7/16	20 UNF	-07	11.1	0.44	9.9	0.39	1/4
1/2	20 UNF	-08	12.7	0.5	11.4	0.45	5/16
9/16	18 UNF	-09	14.3	0.56	13.0	0.51	3/8
3/4	16 UNF	-12	19.1	0.75	17.5	0.69	1/2
7/8	14 UNF	-14	22.2	0.88	20.3	0.80	5/8
1-1/16	12 UNF	-17	27.0	1.06	24.9	0.98	3/4
1-3/16	12 UNF	-19	30.2	1.19	28.2	1.11	7/8
1-5/16	12 UNF	-21	33.3	1.31	31.2	1.23	1
1-7/8	12 UNF	-30	47.6	1.88	45.5	1.79	1-1/2
2-1/2	12 UNF	-40	63.5	2.50	61.5	2.42	2

JIS BSP INVERTED CONE

METAL SEAL

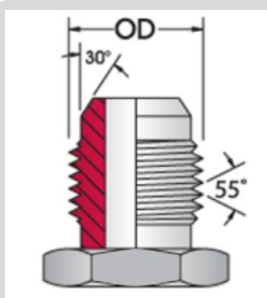

QUICK ID

Sealing Method:	30° cone seat
Thread Form:	55°
Thread Standard:	Whitworth
JIS B 0202	ISO 228-1 BS 2779

T200	T400	T700	T900	6900N	1100	800	3300	600
✓	✓							✓

JIS JAPANESE INDUSTRIAL STANDARD

Often confused with JIC connectors at first glance, JIS Inverted Cone differs from JIC connectors in both thread form and seat angle.

The thread is identical to BSPP.

This connector form is commonly used on Toyota® and Mitsubishi® forklifts.

JIS THREAD SIZE & PTICH		DASH SIZE	JIS / BSPP MALE THREAD OD		JIS / BSPP FEMALE THREAD ID	
INCH	TPI		mm	INCH	mm	INCH
1/8	28	-02	9.6	0.38	8.6	0.34
1/4	19	-04	13.0	0.51	11.9	0.47
3/8	19	-06	16.5	0.65	15.2	0.60
1/2	14	-08	20.8	0.82	19.1	0.75
3/4	14	-12	26.3	1.04	24.6	0.97
1	11	-16	33.1	1.30	30.7	1.21
1-1/4	11	-20	41.8	1.64	39.4	1.55
1-1/2	11	-24	47.7	1.88	45.5	1.79
2	11	-32	59.5	2.34	57.4	2.26

JIS METRIC INVERTED CONE

METAL SEAL

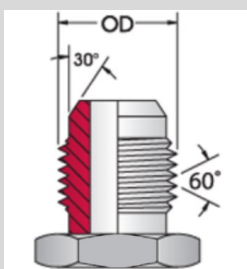

QUICK ID

Sealing Method: 30° cone seat
 Thread Form: 60°
 Thread Standard: JIS B 8363
 Male Type M Female Type MU

T200 ✓ T400 T700 ✓ T900 6900N 1100 800 3300 600

JIS JAPANESE INDUSTRIAL STANDARD

Similar in form and function to JIS BSP Inverted cone (Page 25) however a metric thread is used.

Commonly used on Komatsu® equipment.

JIS THREAD SIZE & PTICH		DASH SIZE	FEMALE THREAD ID	KOMATSU	JIS B 8363
SIZE	PITCH		mm		
M14	1.5	-14	12.5	✓	✓
M16	1.5	-16	14.5	✓	
M18	1.5	-18	16.5		✓
M22	1.5	-22	20.5		✓
M24	1.5	-24	22.5	✓	
M27	2.0	-27	25.0		✓
M30	1.5	-30	28.5	✓	
M33	1.5	-33	31.5	✓	
M33	2.0	-33	31.0		✓
M36	1.5	-36	34.5	✓	
M42	1.5	-42	40.5	✓	
M50	2.0	-50	48.0		✓
M60	2	-60	58		✓

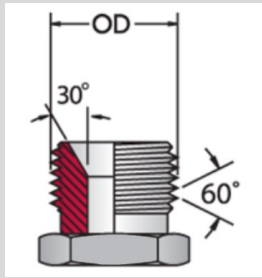

QUICK ID

Sealing Method:
Thread Form:
Thread Standard:

30° cone seat
60°
DIN 7631

T200 T400 T700 T900 6900N 1100 800 3300 600

DKM METRIC CONE AND GLOBE

This connection works like BSPP and NPSM as it incorporates a 30° cone seat. The seat of the female uses a spherical seat as per DIN 3863. Unlike DKL & DKS, this connector cannot accept tube.

The DIN male 60° internal cone seat will mate with DKL/DKM female universal 24°/60° cone fittings up to and including size M26 and DKM female 60° cone fittings from size M30 up.

DKM MALE THREAD SIZE & PITCH		DKM FEMALE THREAD ID
SIZE	PITCH	mm
M12	1.5	10.5
M14	1.5	12.5
M16	1.5	14.5
M18	1.5	16.5
M22	1.5	20.5
M26	1.5	24.5
M30	1.5	28.5
M38	1.5	36.5
M45	1.5	43.5
M52	1.5	50.5

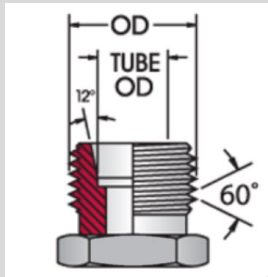

QUICK ID

Sealing Method:

12° Cone Seat

Thread Form:

60°

Thread Standard:

DIN 3853

24° cone seat: DIN 2353

ISO 8434-1

T200

T400

T700

T900

6900N

1100

800

3300

600



DKL METRIC LIGHT SERIES 24° CONE

This connection can seal both tube and hose couplings. When sealing with tube it uses a “bite ring”. The same thread is commonly used in ports.

Code	DKL MALE SIZE & PITCH		TUBE SIZE	DKL Female Thread ID
	SIZE	PITCH	mm	mm
6L	M12	1.5	6	10.5
8L	M14	1.5	8	12.5
10L	M16	1.5	10	14.5
12L	M18	1.5	12	16.5
15L	M22	1.5	15	20.5
18L	M26	1.5	18	24.5
22L	M30	2.0	22	28.0
28L	M36	2.0	28	34.0
35L	M45	2.0	35	43.0
42L	M52	2.0	42	50.0

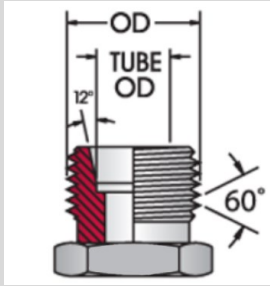

QUICK ID

Sealing Method: 12° Cone Seat
 Thread Form: 60°
 Thread Standard: DIN 3853
 24° cone seat: DIN 2353 ISO 8434-1

T200 ✓ T400 T700 ✓ T900 ✓ 6900N ✓ 1100 800 3300 600 ✓

DKS METRIC HEAVY SERIES 24° CONE

This connection can seal both tube and hose couplings. When sealing with tube it uses a “bite ring”.

Code	DKL MALE SIZE & PITCH		TUBE SIZE	DKL Female Thread ID
	SIZE	PITCH	mm	mm
6S	M14	1.5	6	12.5
8S	M16	1.5	8	14.5
10S	M18	1.5	10	16.5
12S	M20	1.5	12	18.5
14S	M22	1.5	14	20.5
16S	M24	1.5	16	22.5
20S	M30	2.0	20	28
25S	M36	2.0	25	34
30S	M42	2.0	30	40
38S	52	2.0	38	50.

SAE (45° FLARE)

METAL SEAL

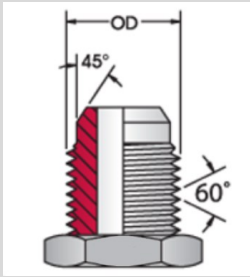

QUICK ID

Sealing Method:
Thread Form:
Thread Standard:

45° Cone Seat
60°
SAE J512

T200 ✓ T400 T700 ✓ T900 ✓ 6900N ✓ 1100 800 3300 600 ✓

SAE SOCIETY OF AUTOMOTIVE ENGINEERS

Similar in form to JIC, these connectors are commonly used in refrigeration, automotive and low pressure applications. Copper tube is often used with SAE threads.

SAE THREAD SIZE & PITCH		DASH SIZE	SAE MALE THREAD OD		SAE MALE THREAD ID		TUBE SIZE
INCH	TPI		mm	INCH	mm	INCH	INCH
5/16	24	-05	7.9	0.31	6.8	0.27	1/8
3/8	24	-06	9.5	0.38	8.4	0.33	3/16
7/16	20	-07	11.1	0.44	9.9	0.39	1/4
1/2	20	-08	12.7	0.5	11.4	0.44	5/16
5/8	18	-10	15.9	0.63	14.2	0.56	3/8
3/4	16	-12	19.1	0.75	17.5	0.69	1/2
7/8	14	-14	22.2	0.88	20.6	0.81	5/8
1-1/16	14	-17	27.0	1.06	24.9	0.98	3/4

SAE INVERTED FLARE

METAL SEAL

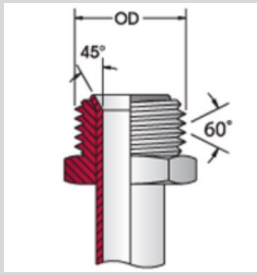

QUICK ID

Sealing Method:
Thread Form:
Thread Standard:

45° Cone Seat
60°
SAE J512

T200 ✓ T400 ✓ T700 T900 6900N 1100 800 3300 600 ✓

SAE SOCIETY OF AUTOMOTIVE ENGINEERS

Tube is flared to 45°, the same as with SAE threads on page 22. The difference being that the nut has a male thread instead of a female thread.

The tube is often double flared for this connector.

THREAD SIZE & PITCH		DASH SIZE	MALE THREAD OD		FEMALE THREAD ID		TUBE SIZE
INCH	TPI		mm	INCH	mm	INCH	INCH
7/16	24	-07	11.1	0.44	9.9	0.39	1/4
1/2	20	-08	12.7	0.50	11.4	0.45	5/16
5/8	18	-10	15.9	0.63	14.2	0.56	3/8
11/16	18	-11	17/5	0.69	16.0	0.63	7/16

TEST POINT (THREADED)

METAL SEAL (BALL & SEAT, OR POPPET & SEAT)



7200

v

QUICK ID

Sealing Method:
Test 12 uses Poppet & Seat

Ball & Seat

TEST POINT THREADED

European test points are threaded. These test points seal with an internal spring-loaded poppet, or ball and seat.

Different manufacturers produce different forms, but generally these are interchangeable if the threads are the same size and pitch.

THREAD SIZE & PITCH		COMMON NAME	NOTES
SIZE	PITCH		
M16	1,5	TEST 15	
M16	2.0	TEST 20	
M12.65	1.5	TEST 12	Buttress thread (Sawtooth form)

TEST POINT (QUICK RELEASE)

METAL SEAL (POPPET & SEAT)

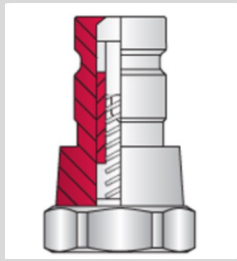

QUICK ID

Sealing Method:

Poppet & Seat

Quick Connect Coupling

Predominately used in North America

SAE J1502

T200

T400

T700

T900

6900N

1100

800

3300

600

SAE SOCIETY OF AUTOMOTIVE ENGINEERS

Quick connect couplings are commonly used as test points in the North American market.

The Standard is SAE J1502, the spigot is 1/2" diameter and seat groove is 1/4" from the front face.

BSPP

SOFT SEAL

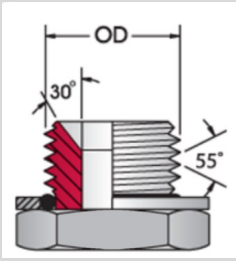

QUICK ID

Sealing Method:

Soft seal at shoulder or
30° cone seat

Thread form:

55°

Thread standard:

Whitworth

T200



T400



T700



T900



6900N

1100

800



3300



600

BSPP BRITISH STANDARD PIPE PARALLEL

BSPP threads are used as both general adaptors and as port adaptors. Soft sealing is usually required for port use.

BS5200:1997 allows for two sealing forms on the face of the female, Type C is conical and Type S is spherical

BSPP THREAD SIZE & THREAD		DASH SIZE	BSPP MALE THREAD OD		BSPP FEMALE THREAD ID	
INCH	TPI		mm	INCH	mm	INCH
1/8	28	-02	9.6	0.38	8.6	0.34
1/4	19	-04	13.0	0.51	11.9	0.47
3/8	19	-06	16.5	0.65	15.2	0.6
1/2	14	-08	20.8	0.82	19.1	0.75
5/8	14	-10	22.8	0.90	20.8	0.82
3/4	14	-12	26.3	1.04	24.6	0.97
1	11	-16	33.1	1.30	30.7	1.21
1-1/4	11	-20	41.8	1.64	39.4	1.55
1-1/2	11	-24	47.7	1.88	45.5	1.79
2	11	-32	59.5	2.34	57.4	2.26
2-1/2	11	-40	75.1	2.95	72.6	2.86
3	11	-48	87.9	3.46	85.4	3.36

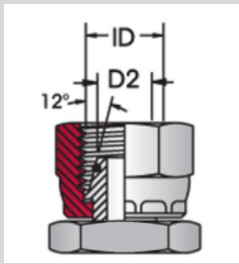

QUICK ID

Sealing Method: 12° cone seat
 Thread form: 60°
 Thread standard: DIN 3853
 24° cone seat: DIN 2353 ISO 8434-1

T200 ✓ T400 T700 ✓ T900 ✓ 6900N ✓ 1100 800 3300 600 ✓

DKOL METRIC LIGHT O RING SERIES 24° CONE

When a soft seal is used, an “O” is added to the acronym to signify an O ring seal.

CODE	THREAD SIZE & PITCH		TUBE SIZE	DKOL FEMALE THREAD ID
	SIZE	PITCH	mm	mm
6L	M12	1.5	6	10.5
8L	M14	1.5	8	12.5
10L	M16	1.5	10	14.5
12L	M18	1.5	12	16.5
15L	M22	1.5	15	20.5
18L	M26	1.5	18	24.5
22L	M30	2.0	22	28.0
28L	M36	2.0	28	34.0
35L	M45	2.0	35	43.0
42L	M52	2.0	42	50.0

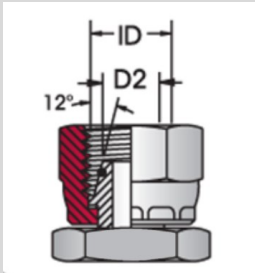

QUICK ID

Sealing Method: 12° cone seat
 Thread form: 60°
 Thread standard: DIN 3853
 24° cone seat: DIN 2353 ISO 8434-1

T200 ✓ T400 T700 ✓ T900 ✓ 6900N ✓ 1100 800 3300 600 ✓

DKOS METRIC HEAVY O RING SERIES 24° CONE

When a soft seal is used, an “O” is added to the acronym to signify an O ring seal.

CODE	THREAD SIZE & PITCH		TUBE SIZE	DKOS FEMALE THREAD ID
	SIZE	PITCH	mm	mm
6S	M14	1.5	6	12.5
8S	M16	1.5	10	14.5
10S	M18	1.5	10	16.5
12S	M20	1.5	12	18.5
14S	M22	1.5	14	20.5
16S	M24	1.5	16	22.5
20S	M30	2.0	20	28
25S	M36	2.0	25	34
30S	M42	2.0	30	40.0
38S	M52	2.0	38	50.0

ORFS

SOFT SEAL

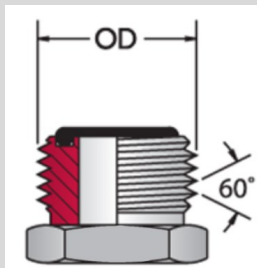

QUICK ID

Sealing Method:

O Ring

Thread form:

60°

Thread standard:

UNF or UNC

ISO8434/3:1995

SAEJ1453

T200



T400



T700



T900



6900N



1100

800

3300

600



ORFS O RING FACE SEAL

The ORFS system consists of an ORFS male with O ring in the face, which seals against a flat seated ORFS female swivel nut fitting.

The swivel nut can be slipped back to help installation.

The prominent position of the O ring on the male fitting makes it easy to inspect the condition of the O ring.

ORFS THREAD SIZE & PITCH		DASH SIZE	ORFS MALE THREAD OD		ORFS FEMALE THREAD ID		TUBE SIZE
INCH	TPI		mm	INCH	mm	INCH	INCH
9/16	18UNF	-09	14.3	0.56	12.9	0.51	1/4
11/16	16UN	-11	17.3	0.68	16.0	0.693	3/8
13/16	16UN	-13	20.6	0.81	19.1	0.75	1/2
1	14UNS	-16	25.4	1.00	23.6	0.73	5/8
1-3/16	12UN	-19	30.0	1.18	28.2	11.1	3/4
1-7/16	12UN	-23	36.3	1.43	34.3	1.35	1
1-11/16	12UN	-27	42.7	1.68	40.6	1.60	1-1/4
2	12UN	-32	51.8	2.00	48.8	1.92	1-1/2

STAPLELOK

SOFT SEAL

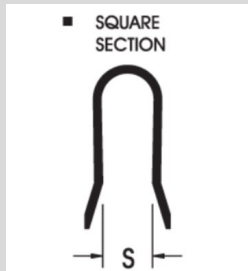
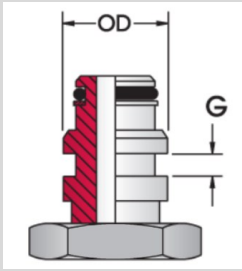

STAPLELOK

T200 ✓ T400 T700 ✓ T900 ✓ 6900N 1100 800 3300 600

Sealing Method: O Ring & Backup washer

Thread form: None

DIN 20043 SAE J1467

The STAPLELOK male connector uses an O ring and backup washer which seals on the smooth bore of the female. The connection is held together by the staple.

The male staple groove (G) aligns with the drilled holes of the female allowing the staple to be inserted .

NOMINAL SIZE			OD		STAPLELOK STAPE SIZE			
					G	G	S	S
DN	INCH	DASH	mm	INCH	mm	INCH	mm	INCH
6	1/4	-06	15	0.59	5.1	0.20	8	0.31
10	3/8	-10	20	0.79	5.1	0.20	13	0.51
12	1/2	-13	24	0.94	5.1	0.20	17	0.67
16	5/8	-16	26	1.02	5.1	0.20	19	0.75
19	3/4	-20	29	1.14	5.1	0.20	22	0.87
25	1	-25	39	1.53	7.1	0.28	29	1.14
31	1-1/4	-32	46	1.81	7.1	0.28	36	1.42
38	1-1/2	-40	55	2.16	7.1	0.28	45	1.77
51	2	-50	64	2.52	7.1	0.28	54	2.13

RYCO CROCBITE

SOFT SEAL

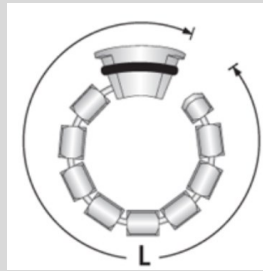
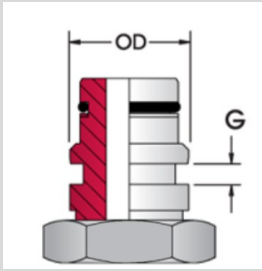

RYCO CROCBITE

T200



T400



T700



T900



6900N



1100

800

3300

600

Sealing Method: O Ring & Backup washer, or profiled seal

Thread form: None

The CROCBITE male uses a rubber seal which seals on the smooth bore of the female. The connection is held together by the CROCTAIL and cannot be disconnected under pressure.

CROCBITE High Pressure and High Flow series' are not interchangeable, however the CROCTAIL is common for both series.

-10 & -12 CROCBITE male & female can interchange with STAPLELOK. -20 CROCBITE female can connect with SAT-

NOMINAL SIZE			OD		GROOVE WIDTH		CROCTAIL LENGTH	
DN	INCH	DASH	mm	INCH	G	G	S	S
			mm	INCH	mm	INCH	mm	INCH
HIGH PRESSURE								
10	3/8	-10	20	0.79	5	0.20	65	2.6
12	1/2	-12	24	0.94	5	0.20	75	3.0
19	3/4	-20	29	1.14	5	0.20	95	3.7
25	1	-25	40	1.57	6	0.24	130	5.1
31	1-1/4	-32	47	1.85	6	0.24	160	6.3
38	1-1/2	-40	56	2.20	6	0.24	190	7.5
51	2	-50	68	2.68	10	0.39	210	8.3
63	2-1/2	-63	88	3.46	10	0.39	250	9.8
76	3	-75	100	3.94	10	0.39	300	11.8
HIGH FLOW								
51	2	-50	69	2.72	10	0.39	210	8.3
63	2-1/2	-63	89	3.50	10	0.39	250	9.8
76	2	-75	101	3.98	10	0.39	300	11.8

RYCO RKV

SOFT SEAL

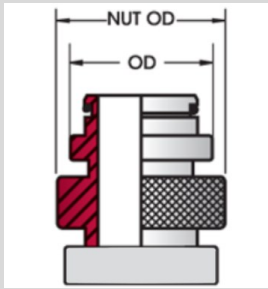

T200 ✓ T400 ✓ T700 ✓ T900 ✓ 6900N ✓ 1100 800 3300 600

RYCO RKV

Sealing Method: O Ring & Backup washer
Thread form: None

This connection is commonly used in air conditioning. The spigot length in front of the tube 'bump' is 4.83mm on the male version.

Sealing is achieved by compressing an O ring against the tube 'bump'. The O ring material is often Hydrogenated Nitrile Butadiene Rubber (HNBR)

NOMINAL SIZE			OD		NUT OD			
DN	INCH	DASH	mm	INCH	COUPLING	ADAPTOR*		
					mm	INCH	mm	INCH
HIGH PRESSURE—RKVP								
10	3/8	-10	20	0.79	25	0.98	29	1.14
12	1/2	-12	24	0.94	30	1.18	34	1.34
19	3/4	-20	30	1.18	40	1.57	40	1.57
25	1	-25	36	1.42	46	1.81	46	1.81
31	1-1/4	-32	44	1.73	52	2.05	59	2.32
38	1-1/2	-40	54	2.13	64	2.52	72	2.83
51	2	-50	70	2.76	78	3.07	85	3.35
63	2-1/2	-63	84	3.31	98	3.86	110	4.33
HIGH FLOW –RKVF								
25	1	-25	33	1.30	42	1.65	42	1.65
31	1-1/4	-32	39.8	1.57	50	1.97	50	1.97
38	1-1/2	-40	53	2.09	64	2.52	72	2.83
51	2	-50	65	2.56	75	2.95	80	3.15
63	2-1/2	-63	75	2.95	85	3.35	90	3.54
76	3	-75	99.3	3.91	110	4.33	125	4.92

SAE PILOT MALE SWIVEL

SOFT SEAL

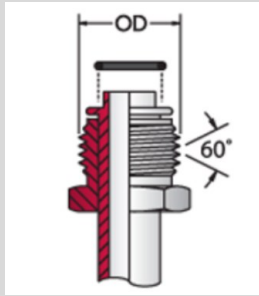

QUICK ID

Sealing Method:
Thread form:
Thread standard:

O ' Ring
60°

1G00
✓

SAE SOCIETY OF AUTOMOTIVE ENGINEERS

This connection is commonly used in air conditioning. The spigot length in front of the tube 'bump' is 4.83mm on the male version.

Sealing is achieved by compressing an O ring against the tube 'bump'. The O ring material is often Hydrogenated Nitrile Butadiene Rubber (HNBR)

THREAD SIZE & PITCH		DASH SIZE	MALE THREAD OD		BEAD DIA	SPIGOT LENGTH	TUBE SIZE
INCH	TPI		mm	INCH	mm	mm	INCH
5/8	18	-10	15.9	0.63	13.2	4.83	-6
3/4	18	-12	19.0	0.75	16.2	4.83	-8
7/8	18	-14	22.2	0.88	19.6	4.83	-10
1-1/16	16	-17	27.0	1.06	23.1	4.83	-12

SAE PILOT FEMALE SWIVEL

SOFT SEAL

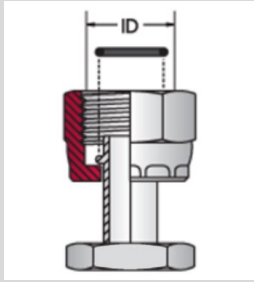

QUICK ID

Sealing Method:
Thread form:

O ' Ring
60°

1G00
√

SAE SOCIETY OF AUTOMOTIVE ENGINEERS

This connection is commonly used in air conditioning. The spigot length in front of the tube 'bump' is 9.91mm on the female version.

Sealing is achieved by compressing an O Ring against the tube 'bump'. The O Ring material is often Hydrogenated Nitrile Butadiene Rubber (HNBR).

FEMALE THREAD SIZE & PITCH		DASH SIZE	FEMALE THREAD ID		BEAD DIA	SPIGOT LENGTH	TUBE SIZE
INCH	TPI		mm	INCH	mm	mm	INCH
5/8	18	-10	14.2	0.56	13.2	9.91	-6
3/4	18	-12	17.8	0.7	16.2	9.91	-8
7/8	18	-14	20.6	0.81	19.6	9.91	-10
1-1/16	16	-17	24.9	0.98	23.1	9.91	-12

SAE FLANGE CODE 61

SOFT SEAL

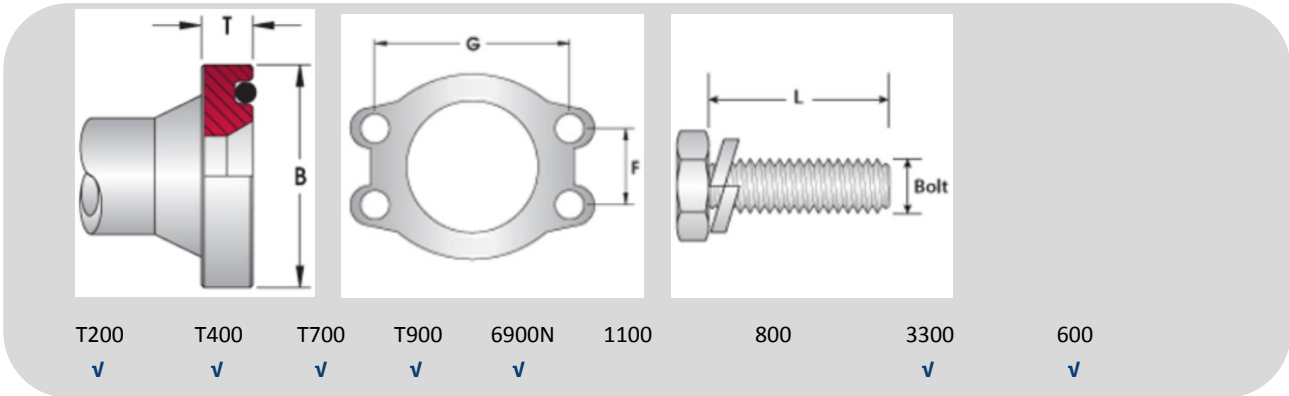

Sealing method: O Ring on flange face

Retained by bolts

Thread form: UNF,UNC or Metric ISO 61612 SAE J518

SAE Code 61 flanges are available in both metric and inch sizes, the difference being the bolt size used. The diameter of the fluid port is usually the nominal size of the flange. Code 61 flanges are used in pressure, suction and return applications. Be advised that O Ring dimensions may change between manufacturers.

*Japanese version is JIS B 8363 Type I, (5/8" size added)

NOMINAL FLANGE SIZE		DASH SIZE		Diameter (B)		THICKNESS (T)		BOLT CENTRES (F)		BOLT CENTRES (G)	
INCH	TPI	mm	INCH	mm	INCH	mm	INCH	mm	INCH	mm	INCH
1/2	-08	30.2	1.19	6.73	0.265	17.5	0.69	38.1	1.50		
5/8*	-10	38.1	1.34	6.73	0.265	19.8	0.78	42.0	1.69		
3/4	-12	38.1	1.50	6.73	0.265	22.2	0.88	47.6	1.88		
1	-16	44.5	1.75	8	0.315	26.2	1.03	52.4	2.06		
1-1/4	-20	50.8	2.00	8.00	0.315	30.2	1.19	58.7	2.31		
1-1/2	-24	60.3	2.38	8.00	0.315	35.7	1.41	69.8	2.75		
2	-32	71.4	2.81	9.53	0.375	42.9	1.69	77.8	3.06		
2-1/2	-40	84.1	3.31	9.53	0.375	50.8	2.00	88.9	3.50		
3	-48	101.6	4.00	9.53	0.75	61.9	2.44	106.4	4.19		

SAE FLANGE CODE 62

SOFT SEAL

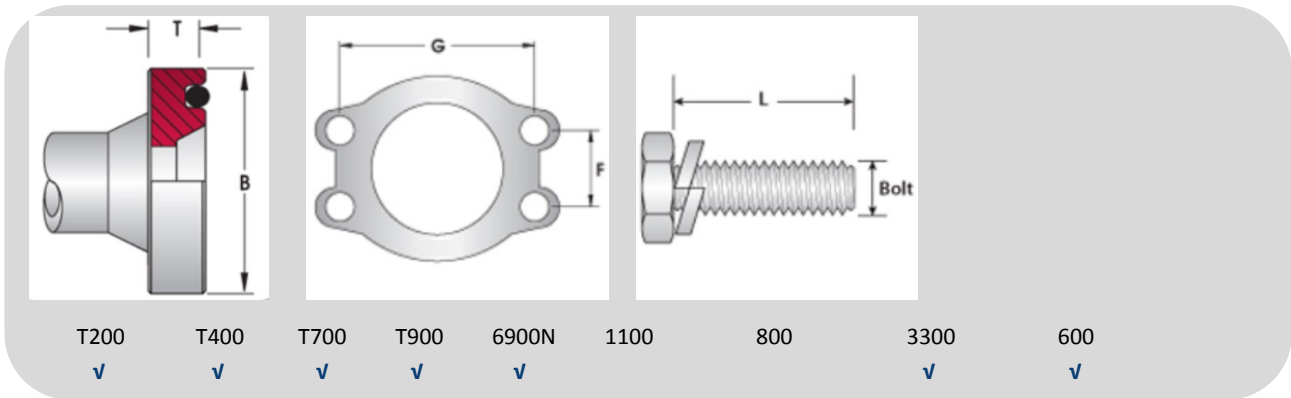

High pressure modification of the code 61 flange

Sealing method: O ring on flange face

Retained by bolts

Thread form: UNF, UNC or Metric ISO 6162 SAE J518

SAE Code 62 flanges are an isobaric version of the code flange. Isobaric means that the pressure rating is consistent across all sizes. All Code 62 flanges are wider and thicker than Code 61 flanges.

Code 62 are only used in pressure ports.

Japanese version us HUS V 8363 Type II.

NOMINAL FLANGE SIZE		DASH SIZE		Diameter (B)		THICKNESS (T)		BOLT CENTRES (F)		BOLT CENTRES (G)	
INCH	TPI	mm	INCH	mm	INCH	mm	INCH	mm	INCH	mm	INCH
1/2	-08	31.7	1.25	7.75	0.305	18.2	0.72	40.5	1.59		
3/4	-12	41.3	1.63	8.76	0.345	23.8	0.94	50.8	2.00		
1	-16	47.6	1.88	9.53	0.375	27.8	1.09	57.2	2.25		
1-1/4	-20	54.0	2.12	10.29	0.405	31.8	1.25	66.7	2.63		
1-1/2	-24	63.5	2.5	12.57	0.495	36.5	1.44	79.4	3.13		
2	-32	79.4	3.13	12.57	0.495	44.5	1.75	96.8	3.81		

NOMINAL FLANGE SIZE		DASH SIZE		UNC BOLT		BOLT LENGTH (L)		METRIC BOLT		BOLT LENGTH	
INCH		UNC		INCH		Metric		mm			
1/2	-08	5/16—18		1-1/4		M8 x 1.25		35			
3/4	-12	3/8—16		1-1/2		M10 x 1.5		40			
1	-16	7/16—14		1-3/4		M12 x 2.0		45			
1-1/4	-20	1/2—13		1-3/4		M14 x 2.0		45			
1-1/2	-24	5/8—11		2-1/4		M16 x 2.0		60			
2	-32	3/4—10		2-3/4		M20 x 2.5		70			

SAE FLANGE CODE 62C

SOFT SEAL

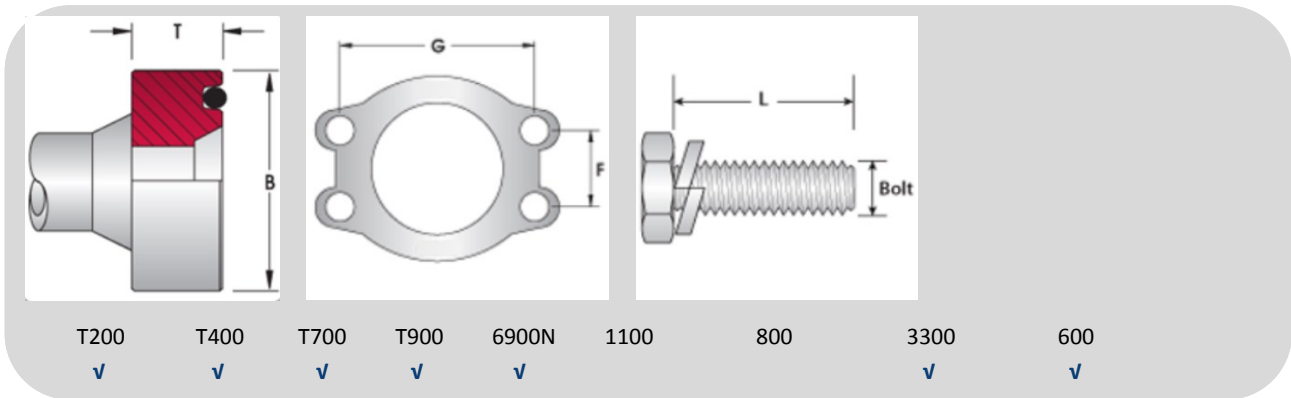

High pressure modification of the code 62 flange

Sealing method: O ring on flange face

Retained by bolts

Thread form: UNF, UNC or Metric

SAE Code 62C flanges are a modification by Caterpillar® of the code 62 flange. In all sizes, the flange thickness is 0.558", (14.2mm)

SAE Code 62C series flanges are isobaric which means that the pressure rating is consistent across all sizes.

Code 62C flanges are visually thicker than standard Code 62 flanges.

NOMINAL FLANGE SIZE	DASH SIZE	Diameter (B)		THICKNESS (T)		BOLT CENTRES (F)		BOLT CENTRES (G)	
INCH		mm	INCH	mm	INCH	mm	INCH	mm	INCH
3/4	-12	41.3	1.63	14.20	0.559	23.8	0.94	50.8	2.00
1	-16	47.6	1.88	14.20	0.559	27.8	1.09	57.2	2.25
1-1/4	-20	54.0	2.12	14.20	0.559	31.8	1.25	66.7	2.63
1-1/2	-24	53.5	2.50	14.20	0.559	36.5	1.44	79.4	3.13

NOMINAL FLANGE SIZE	DASH SIZE	UNC BOLT	BOLT LENGTH (L)	METRIC BOLT	BOLT LENGTH
INCH		UNC	INCH	Metric	mm
3/4	-12	3/8 — 16	1-3/4	M10x1.5	45
1	-16	7/16—14	1-3/4	M12x1.75	45
1-1/4	-20	1/2—13	2	M14x2.0	50
1-1/2	-24	5/8-11	2-1/2	M16x.20	60

UNO (O RING BOSS)

SOFT SEAL

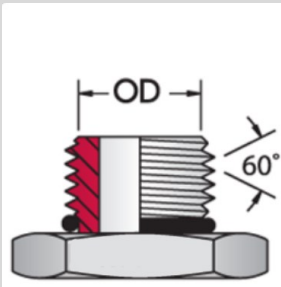

QUICK ID

Sealing Method:

O Ring

Thread form:

60°

Thread standard:

UNF or UNC

ISO11926 SAE J1926

T200



T400

T700



T900



6900N

1100

800



3300



600



UNO UNIFIED NATIONAL, WITH O RING

Very commonly used as a port thread, the UNO, or O Ring Boss is a companion thread for JIC. In all sizes, it uses the same thread as the JIC. It seals with an O ring compressed between the hex boss of UNO male and the 12°/15° tapered bore of the UNO female port

UNO THREAD SIZE & PITCH		DASH SIZE	SAE DASH	UNO MALE THREAD OD	UNO FEMALE THREAD ID		
INCH	TPI			mm	INCH	mm	INCH
5/16	24 UNF	-05	-02	7.9	0.31	6.9	0.27
3/8	24 UNF	-06	-03	9.5	0.38	8.5	0.33
7/16	20 UNF	-07	-04	11.1	0.44	9.9	0.39
1/2	20 UNF	-08	-05	12.7	0.50	11.4	0.45
9/16	18 UNF	-09	-06	14.3	0.56	13.0	0.51
3/4	16 UNF	-12	-08	19.1	0.75	17.5	0.69
7/8	14 UNF	-14	-10	22.2	0.88	20.3	0.80
1-1/16	12 UN	-17	-12	27.0	1.06	24.9	0.98
1-3/16	12 UN	-19	-14	30.2	1.19	28.2	1.11
1-5/16	12 UN	-21	-16	33.3	1.31	31.2	1.23
1-5/8	12 UN	-26	-20	41.3	1.63	39.1	1.54
1-7/8	12 UN	-30	-24	47.6	1.88	45.5	1.79
2-1/2	12 UN	-40	-32	63.5	2.50	61.5	2.42

ISO 6149

SOFT SEAL

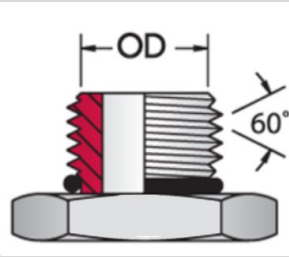

QUICK ID

Sealing Method: O Ring
 Thread form: 60°
 Thread standard: ISO 261
 ISO6149-1 SAE 2244-1 DIN3852 PART 3

T200 T400 T700 T900 6900N 1100 800 3300 600

ISO INTERNATIONAL STANDARDS ORGANISATION

ISO 6149 is a modern port alternative.

ISO 6149 is similar to UNO (O Ring Boss) except that the thread form is metric.

*M14 x 1.5 is recommended for diagnostic port use.

ISO 6149 THREAD SIZE & PITCH		ISO 6149 MALE THREAD OD	ISO 6149 FEMALE THREAD ID
SIZE	PITCH	mm	mm
M8	1.0	8.0	7.0
M10	1.0	10.0	9.0
M12	1.5	12.0	10.5
M14	1.5*	14.0	12.5
M16	1.5	16.0	14.5
M18	1.5	18.0	16.5
M22	1.5	22.0	20.5
M27	2.0	27.0	25.0
M33	2.0	33.0	31.0
M42	2.0	42.0	40.0
M48	2.0	48.0	46.0
M60	2.0	60.0	58.0

PRESSURE WASHER

SOFT SEAL

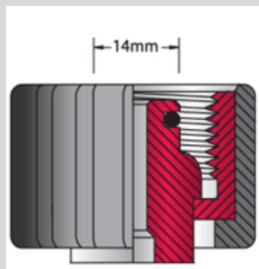

QUICK ID

Sealing Method: O Ring
 Thread form: 60°
 Thread standard: ISO 261
 ISO6149-1 SAE 2244-1 DIN3852 PART 3

T200 T400 T700 T900 6900N 1100 800 3300 600
 ✓

Commonly used on Karcher® industrial and domestic high pressure watch cleaners.

THREAD SIZE & PITCH		DASH SIZE	SPIGOT DIAMETER	SPHERICAL SEAT
SIZE	PITCH		mm	mm
M22	1.5	-22	14	5mm radius